

# GREENHOUSE

## Assembly instruction

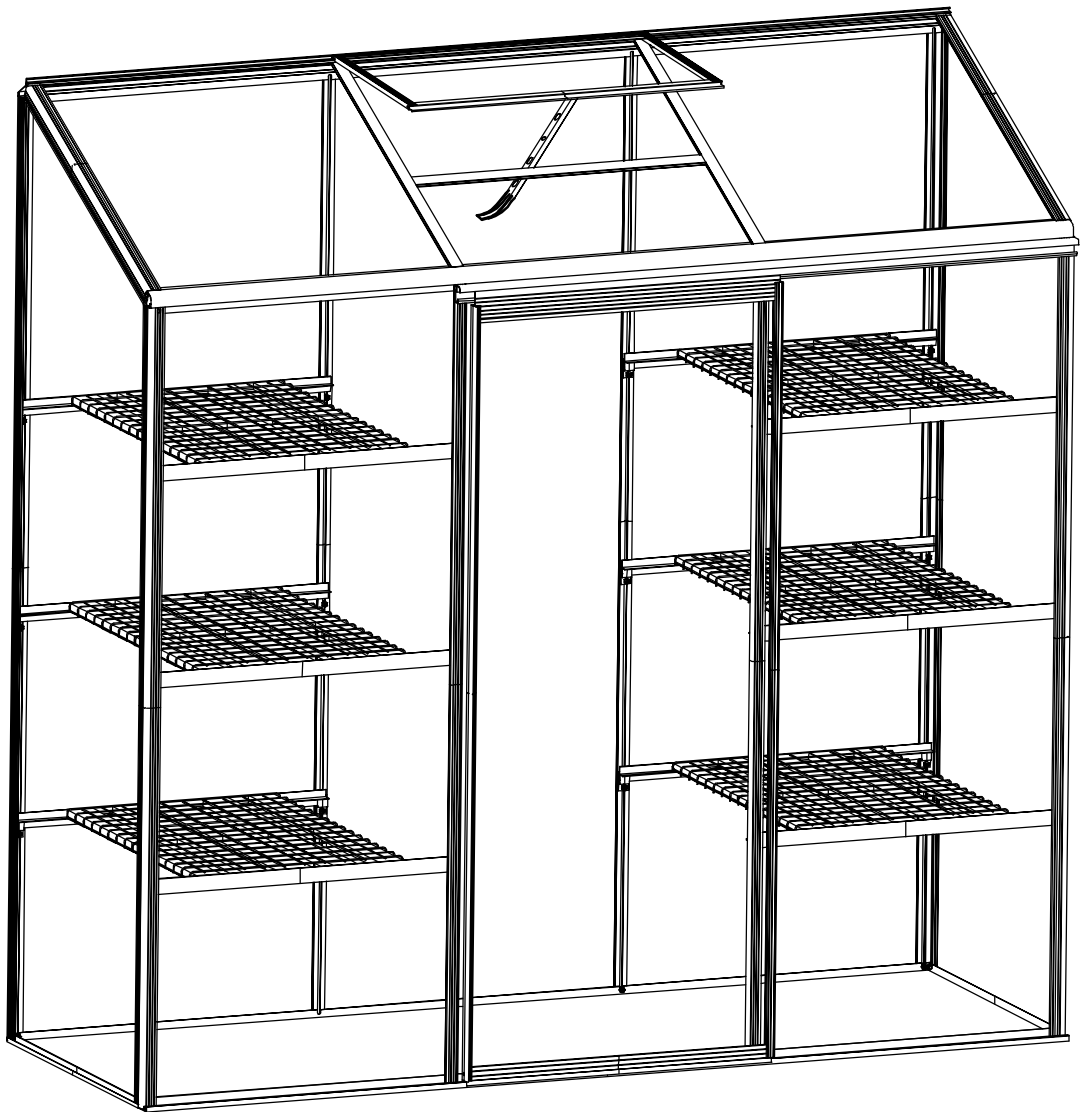



**MODEL:** Sow N Reap Greenhouse







**PRODUCT SIZE(LxWxH)** . . . . .

**PLEASE READ CAREFULLY BEFORE ASSEMBLY**







P2 Door Frame Assembly

PART	NO.	Qty.
	L15	1
	L16A	1
	L18A	2



P7-P9 Assembly

PART	NO.	Qty.
	L01C	1
	L01D	1
	L04A	1
	L04B	1
	L07	1
	L10	1
	L14	1





Polycarbonate

PART	NO.	Qty.
	Y1	2
	Y2	3
	Y3	2
	Y4	1
	Y5	2
	Y6	1
	Y7	1



P3 Window Frame Assembly

PART	NO.	QTY.
	L19	2
	L20	1
	L21	1

















P10-P14 Assembly

PART	NO.	Qty.
	L01B	2
	L03B	1
	L03C	2
	L08B	2





P4 Assembly



PART	NO.	Qty.
	L02A	18
	L09	12

PARTS

PART	NO.	Qty.
	W01	24
	S01	36
	M01	38
	S02	50
	M02	50
	S03	2
	Z01	8
	Z02	6
	Z03	2
	J02L/R	1/1
	J01	2
	J03L/R	1/1
	W07	6
	W06	1
	W08	1
	W04	2



P5-P6 Assembly

PART	NO.	Qty.
	L01A	2
	L03A	2
	L06	1
	L08A	1

PART NO.	Qty.
 L15	1
 L16A	1
 L18A	2

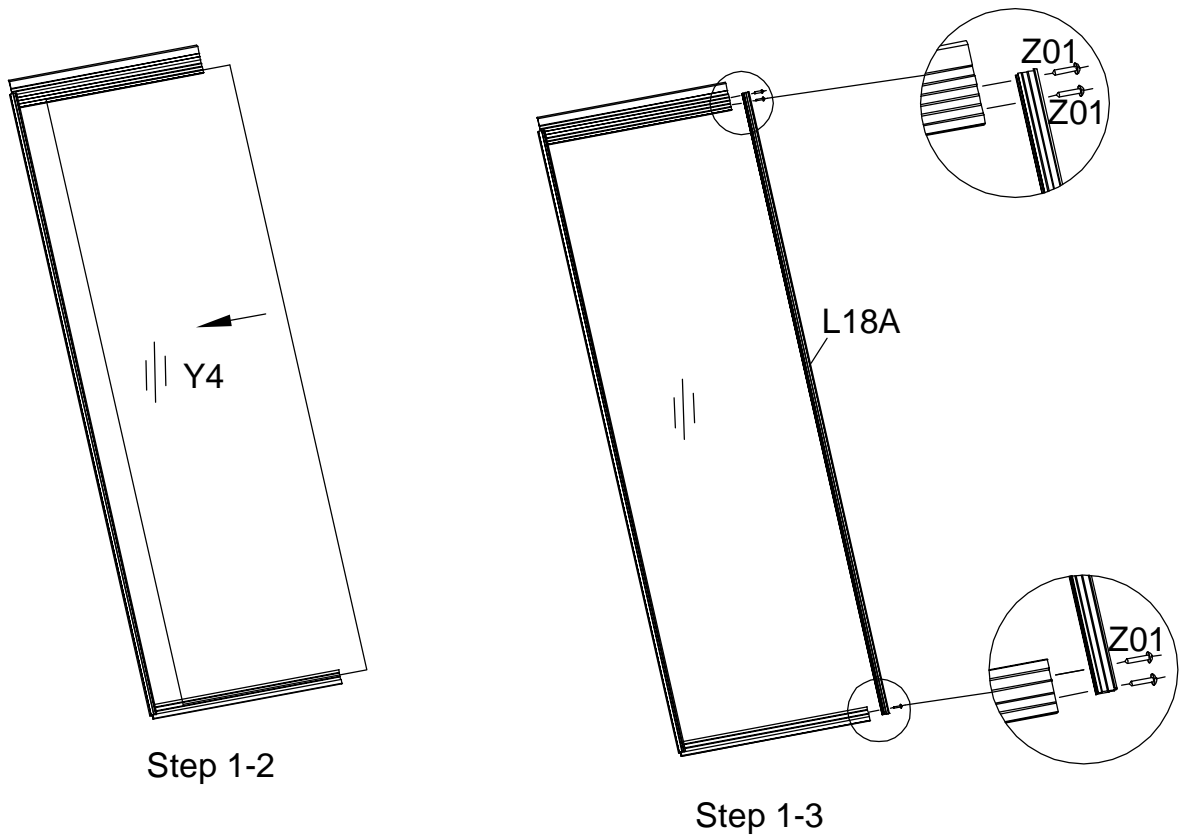
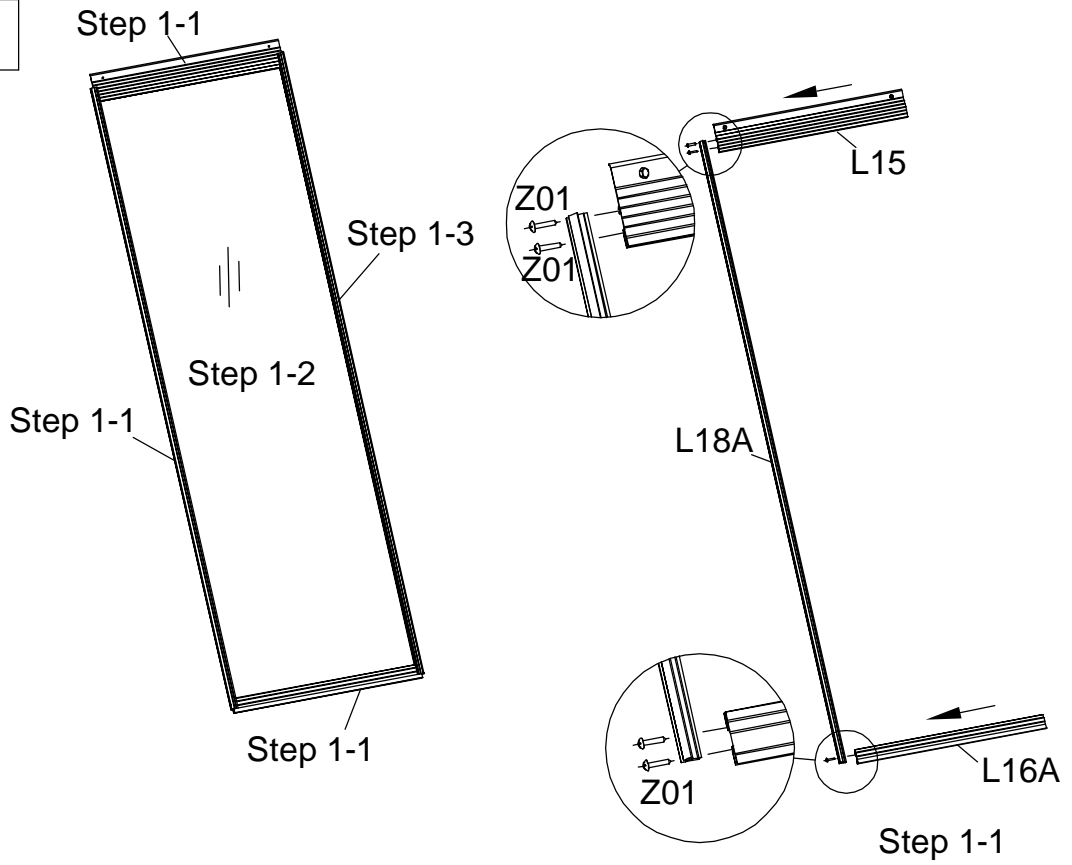

P2 Door Frame Assembly

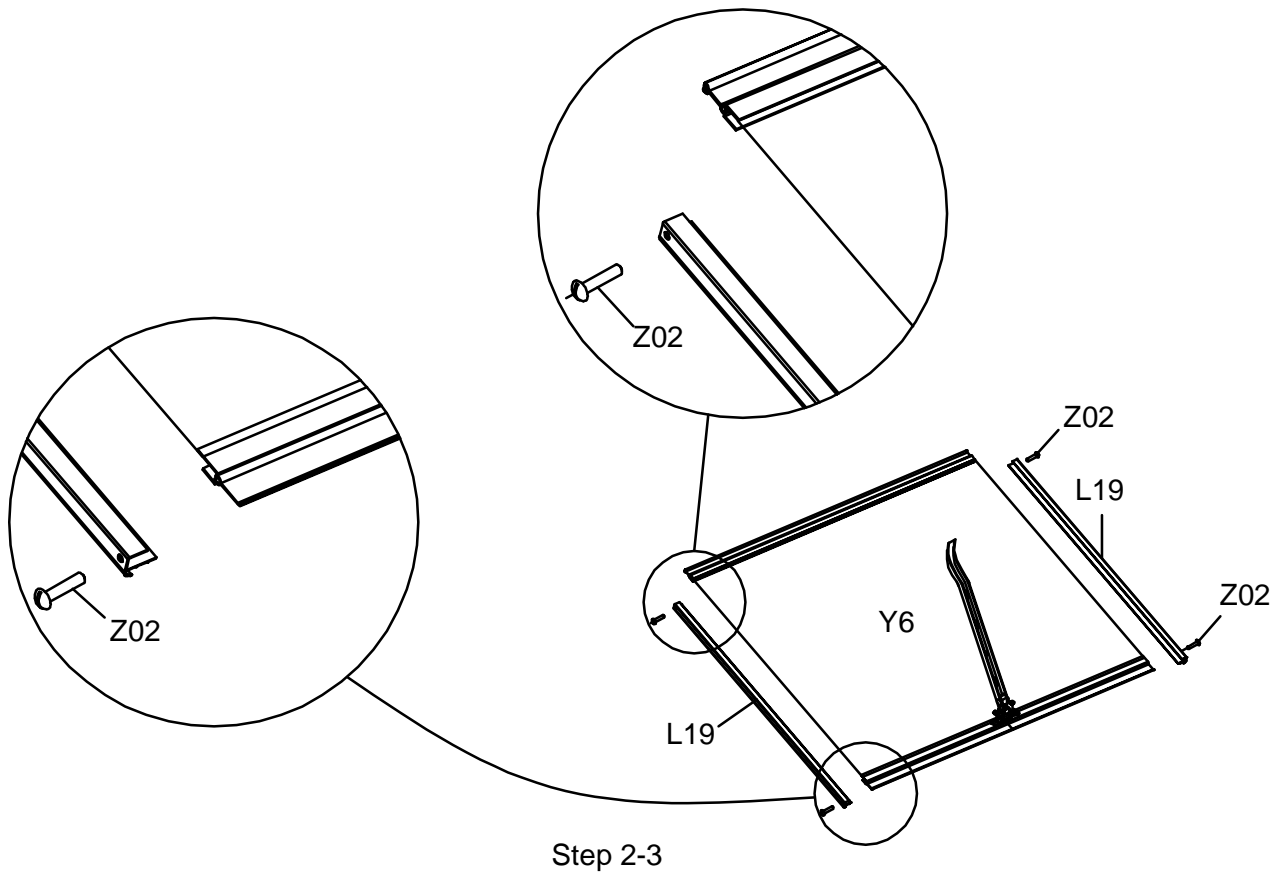
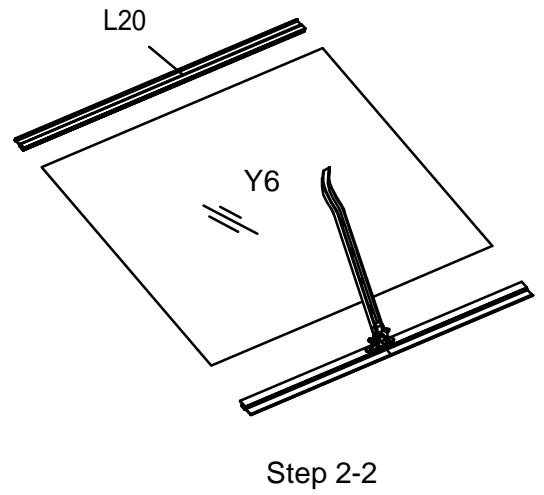
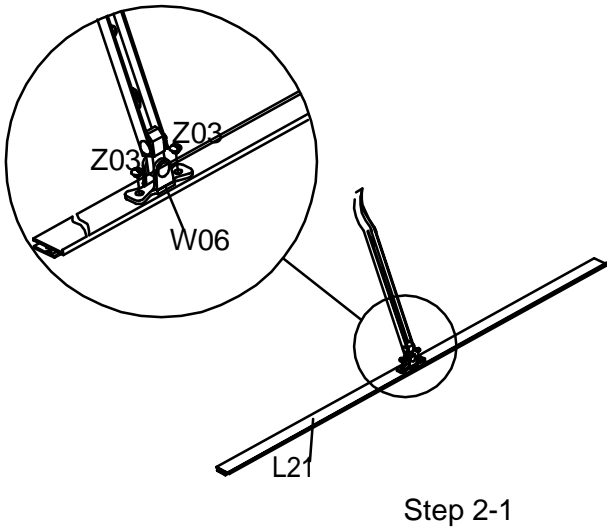
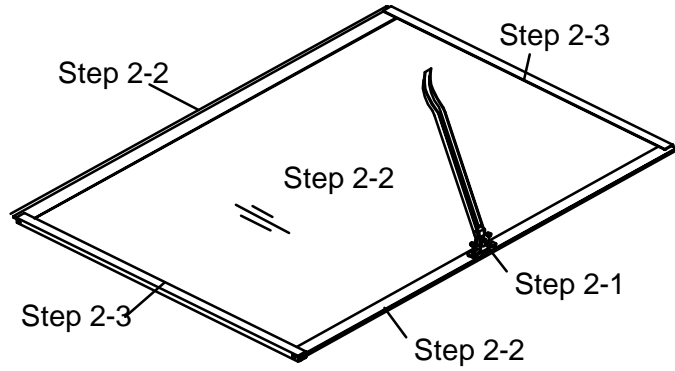

PART	NO.	QTY.
	L19	2
	L20	1
	L21	1

P3 Window Frame Assembly



PART NO.	Qty.
 L02A	18
 L09	12

P4 Assembly

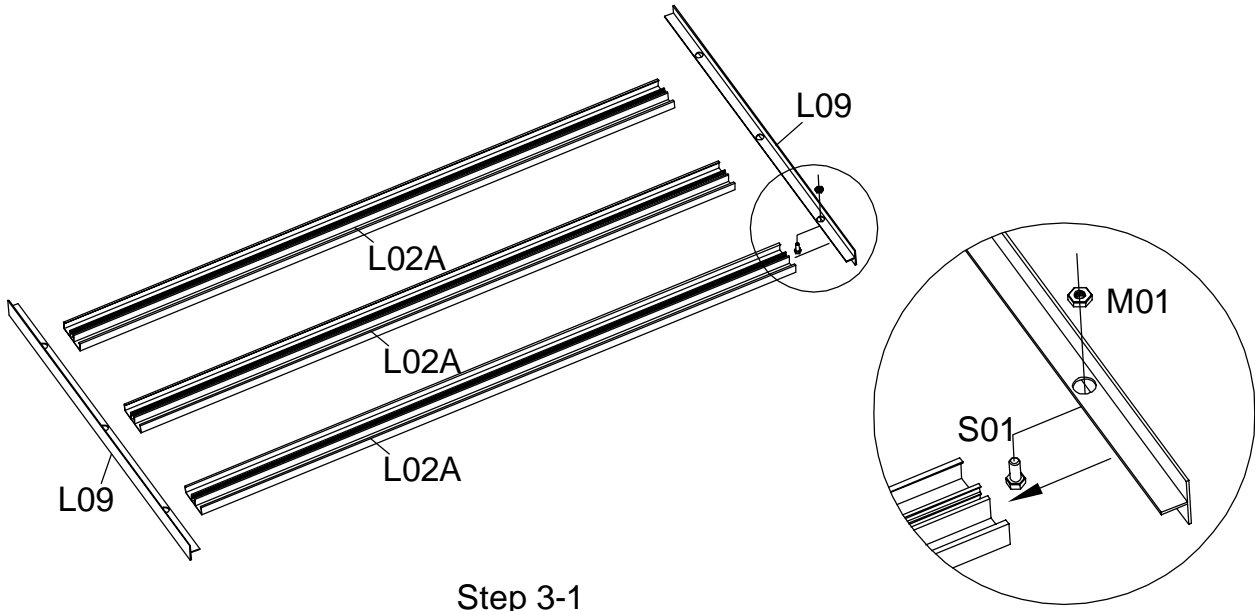



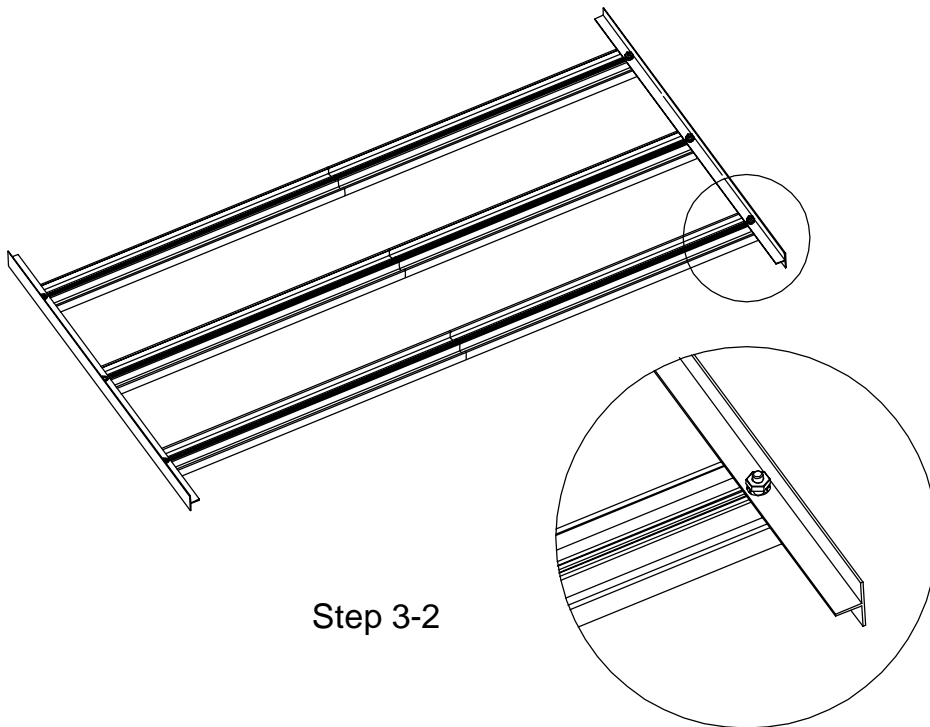

Step 3-1



Step 3-2

P5-P6 Assembly

PART	NO.	Qty.
	L01A	2
	L03A	2
	L06	1
	L08A	1

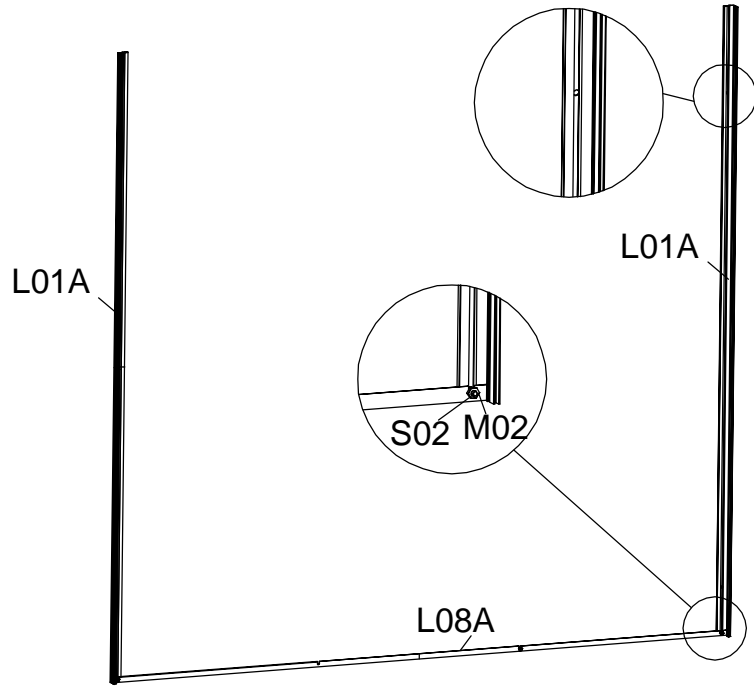

Step 4-1

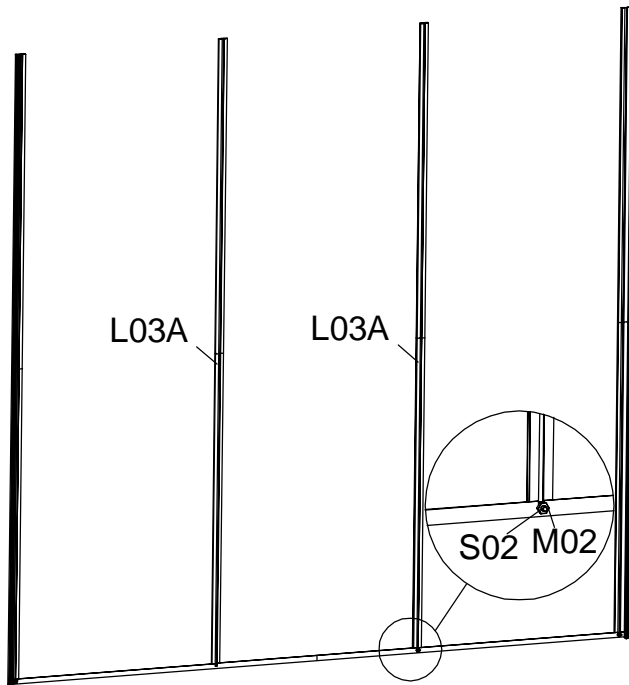

Step 4-2

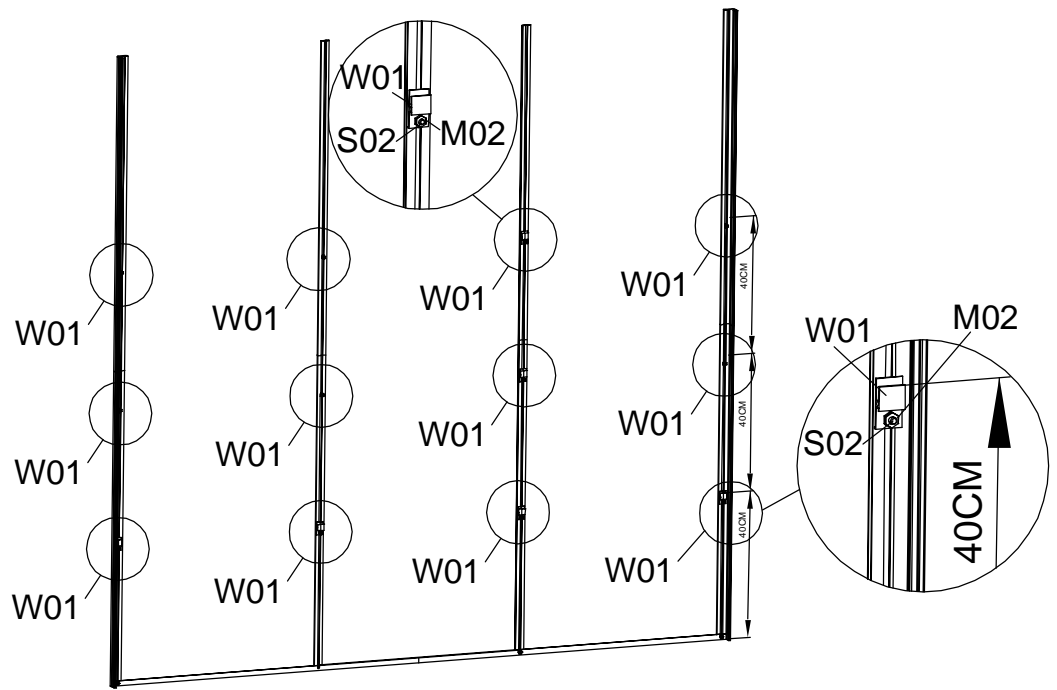



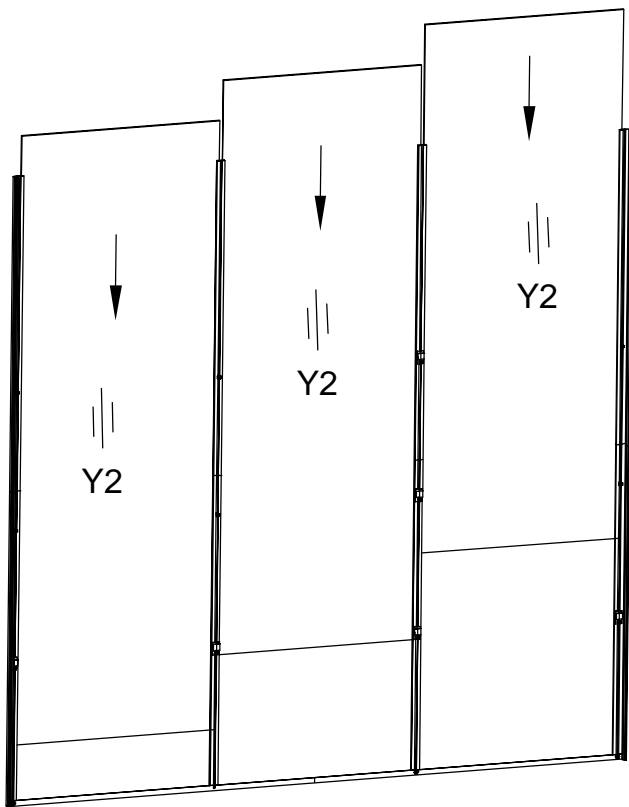

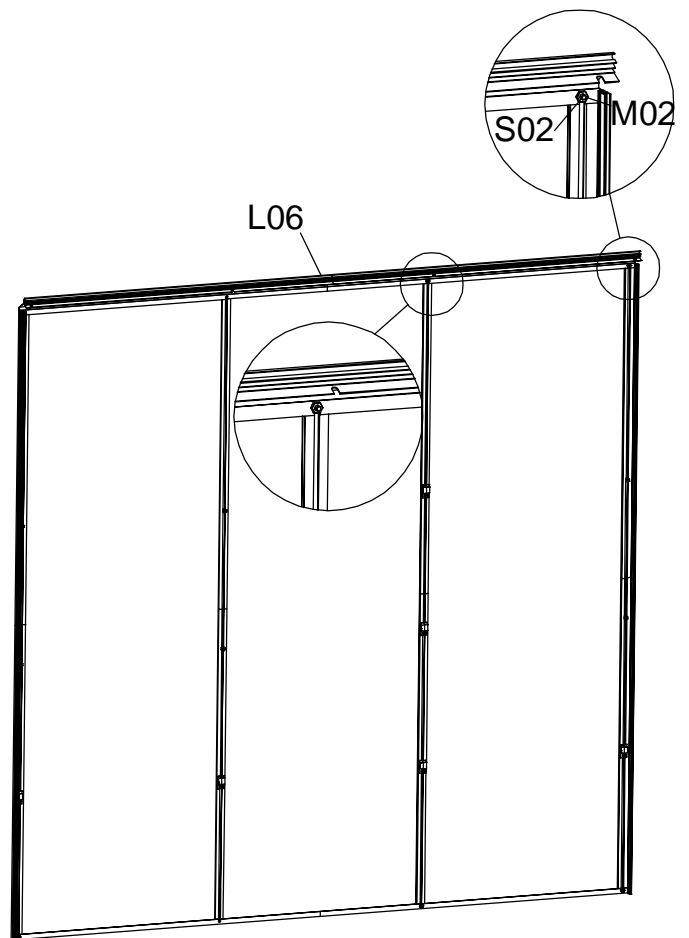

Step 4-3



Step 4-4



Step 4-5

PART	NO.	Qty.
	L01C	1
	L01D	1
	L04A	1
	L04B	1
	L07	1
	L10	1
	L14	1

P7-P9 Assembly

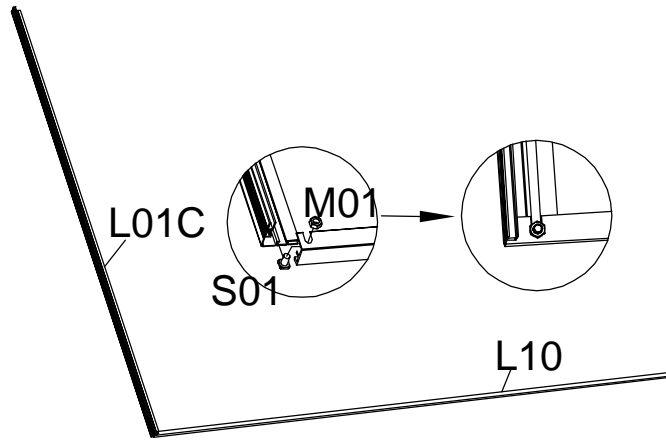

Step 5-1

STEP.16

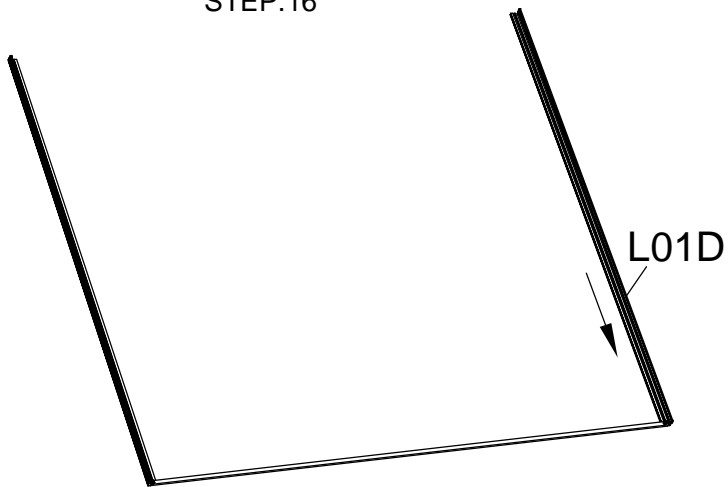

Step 5-2

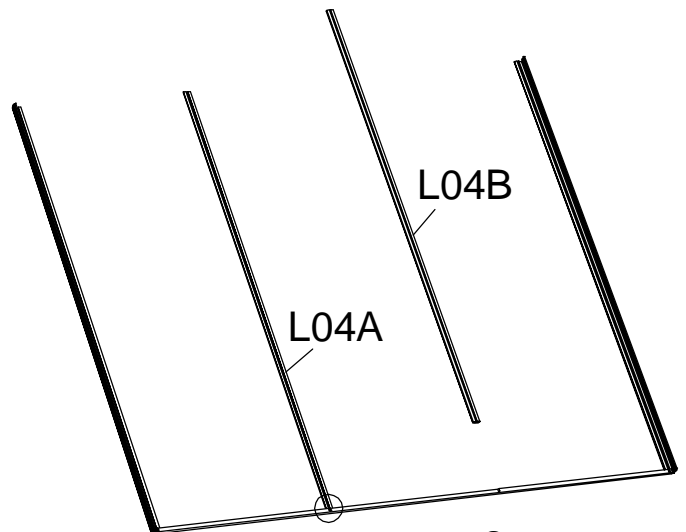

Step 5-3

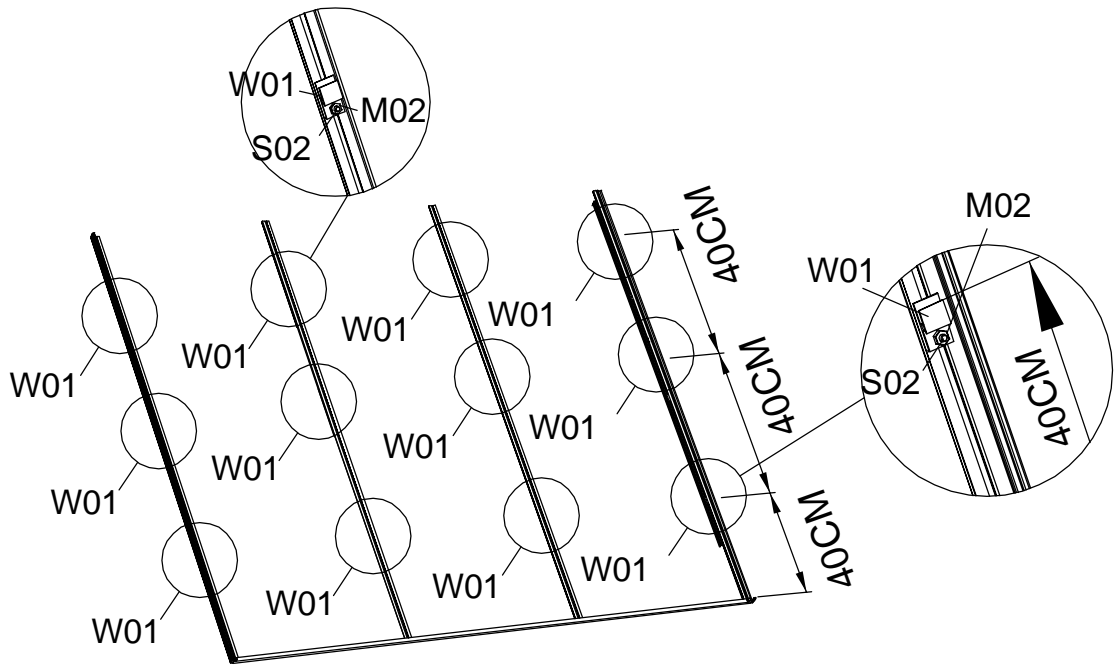

Step 5-4

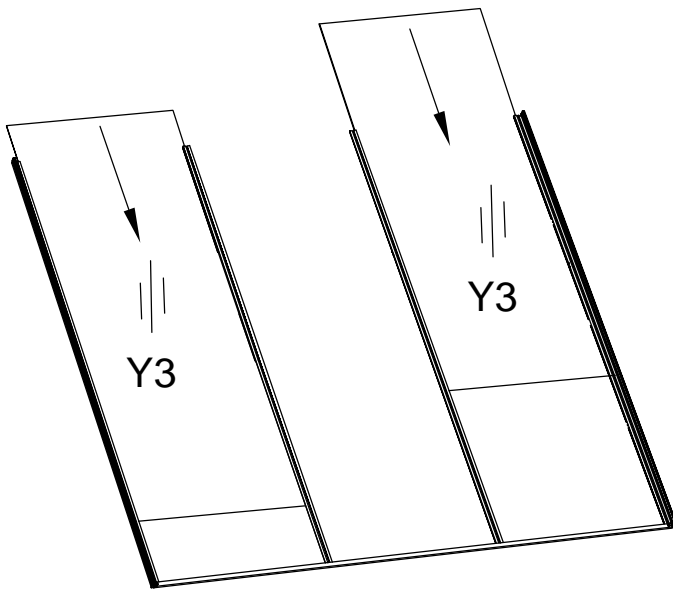

Step 5-5

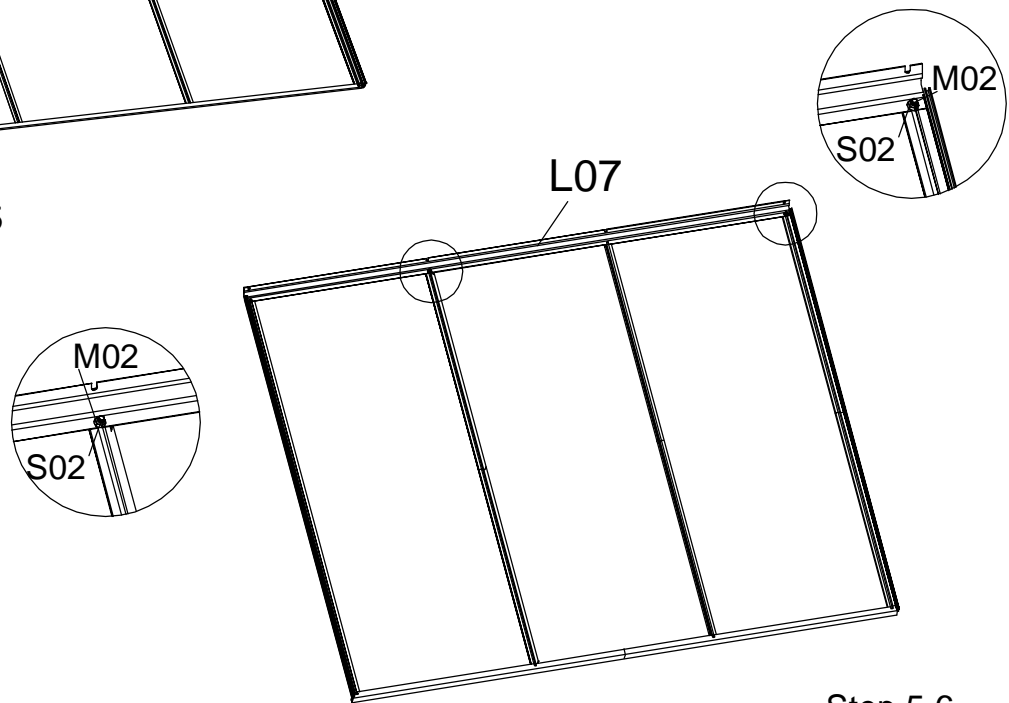



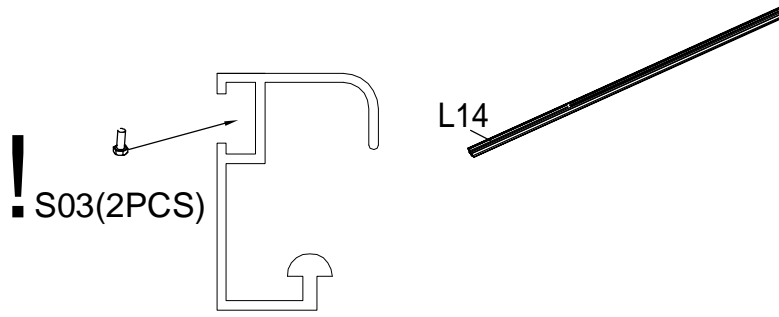

Step 5-6

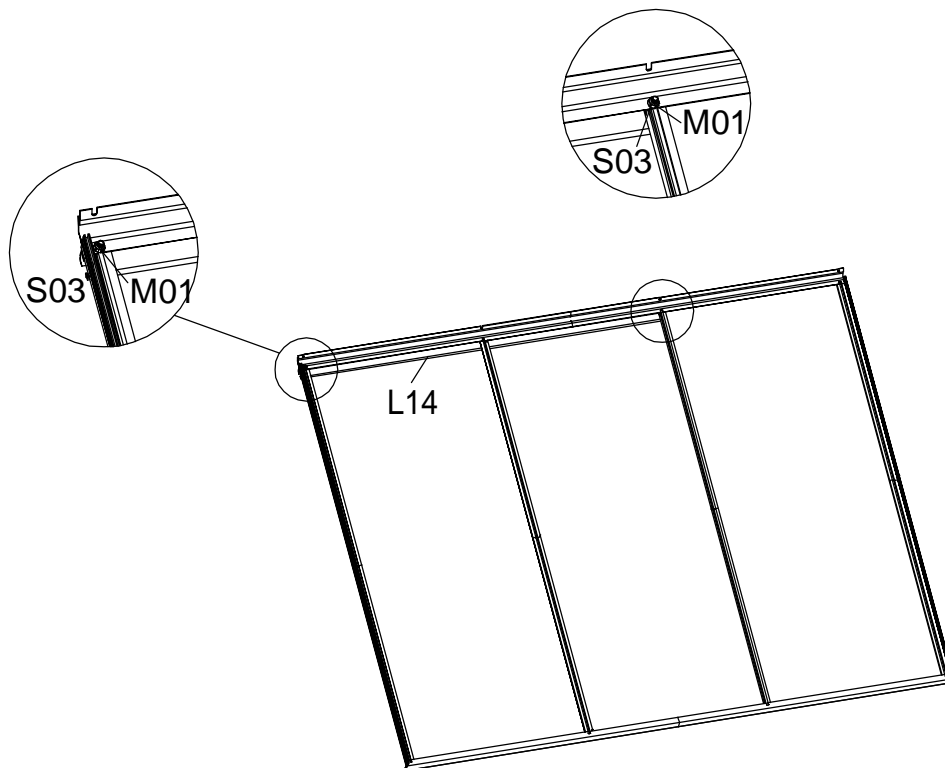

Step 5-7



Step 5-8

PART	NO.	Qty.
	L01B	2
	L03B	1
	L03C	2
	L08B	2

P10-P14 Assembly

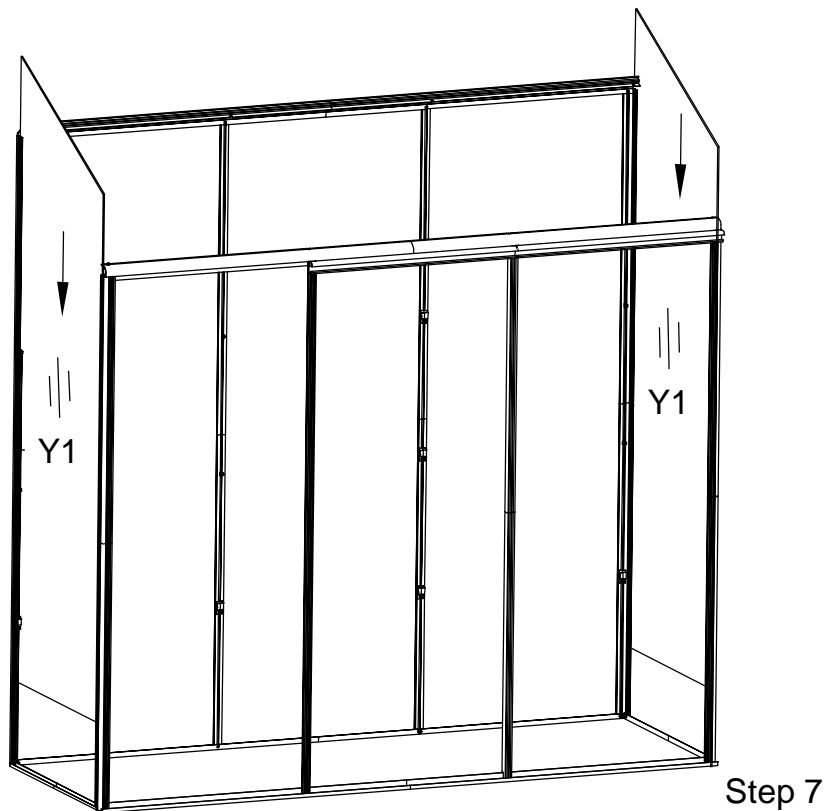
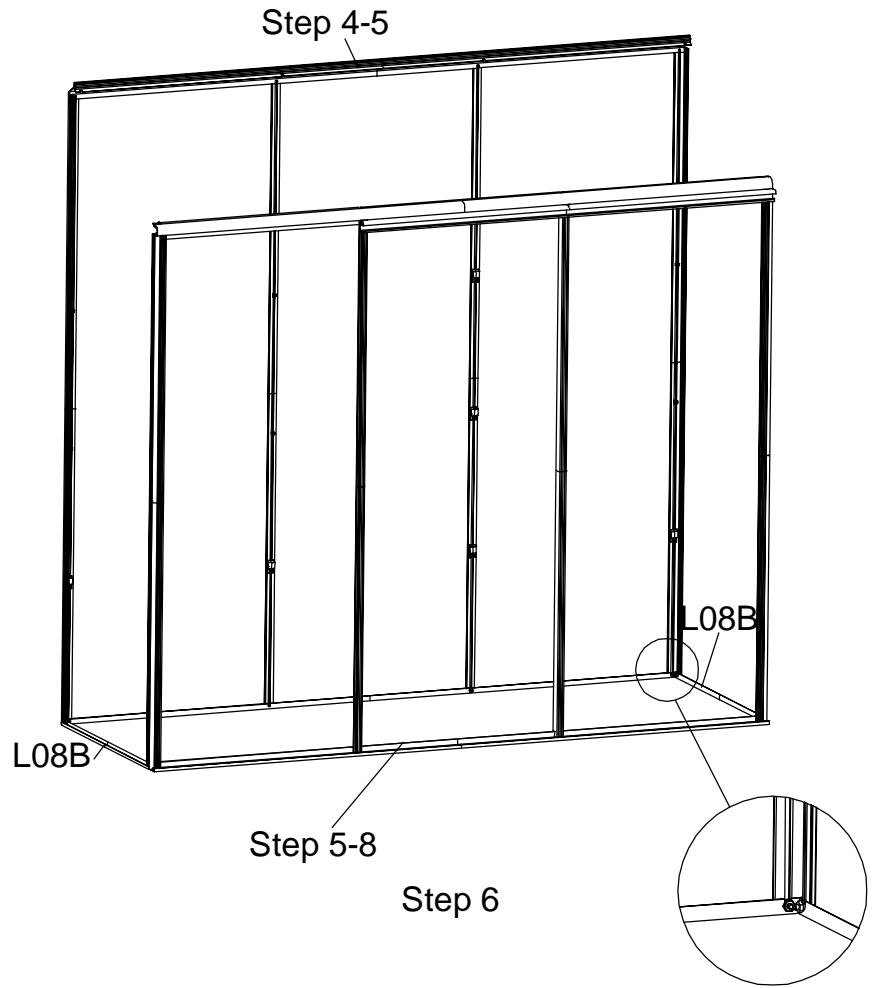

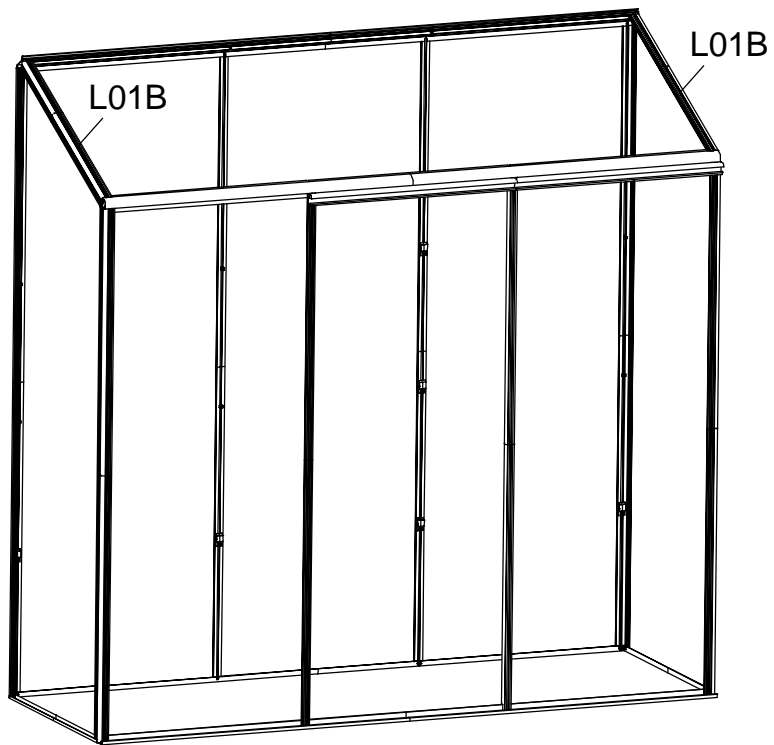

Step 8

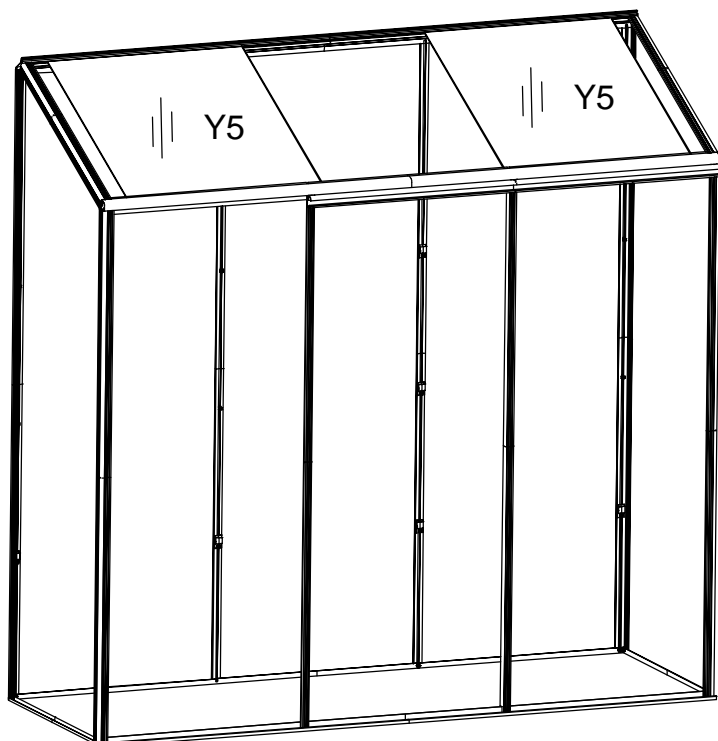

Step 9

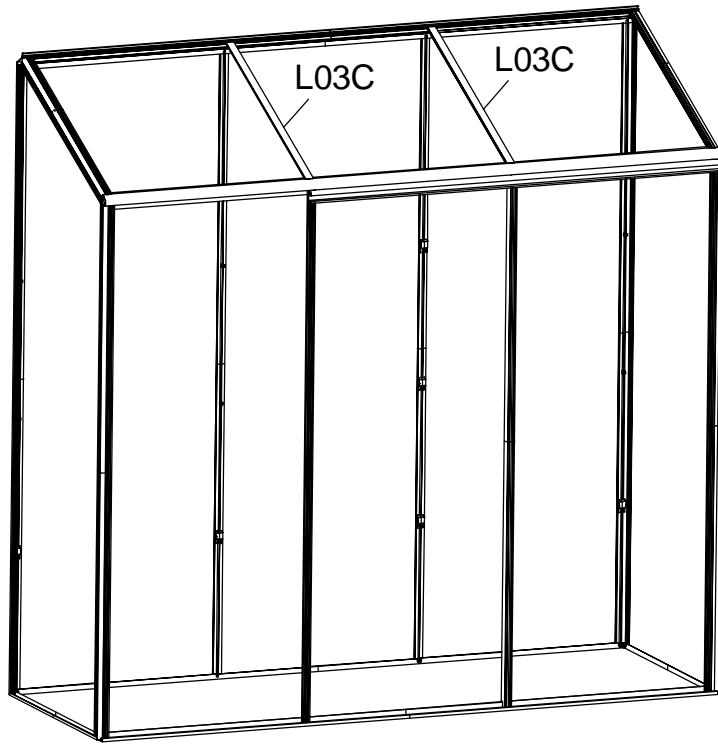

Step 10

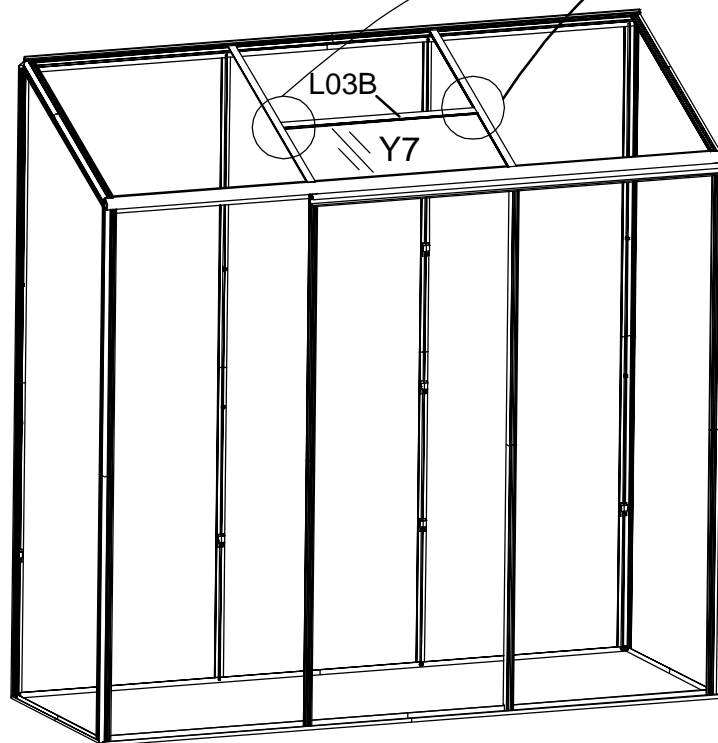
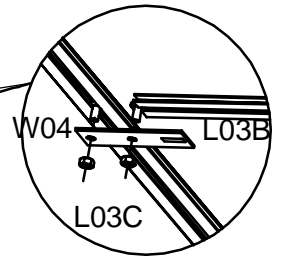
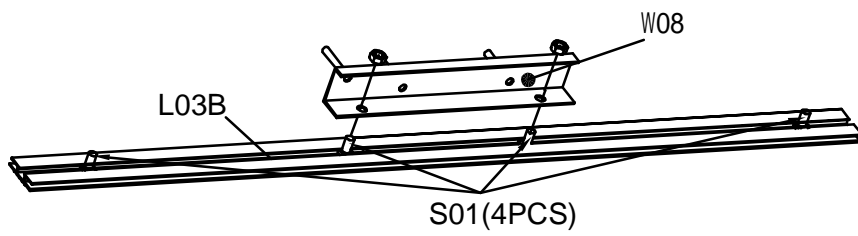

Step 11

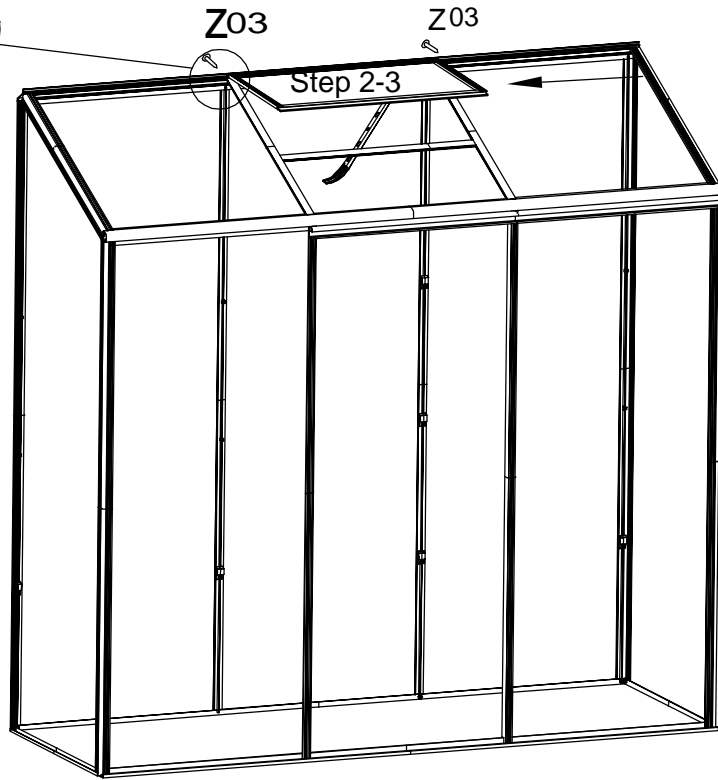

Step 12

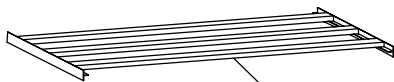

Step 3-2



W07

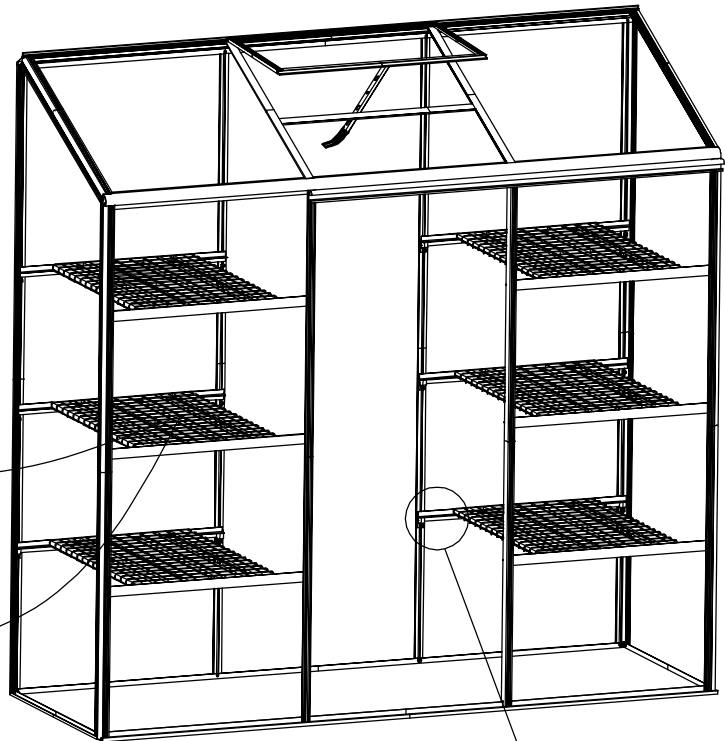

Step 13

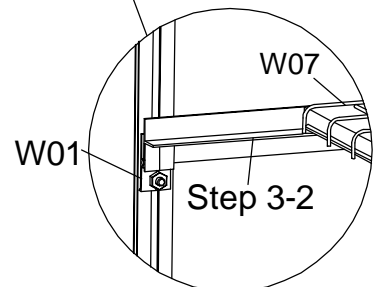

W07

W01

Step 3-2

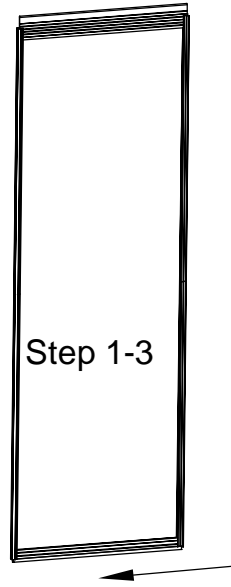
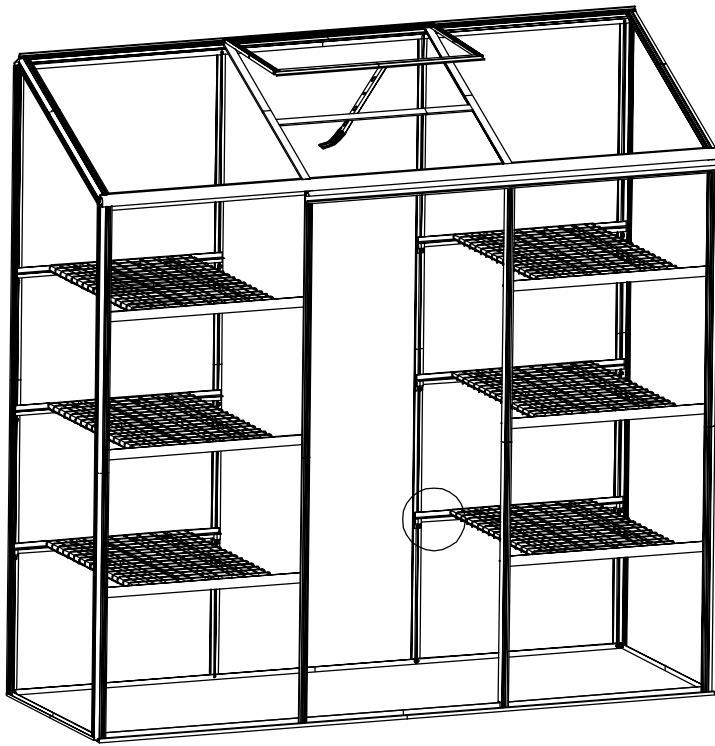

Step 14

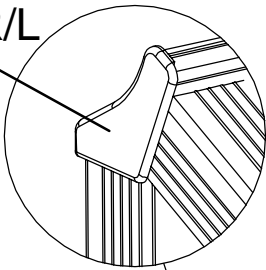

J02R/L

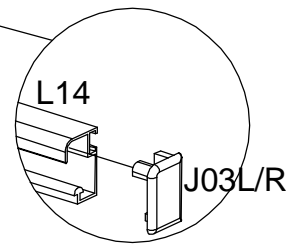
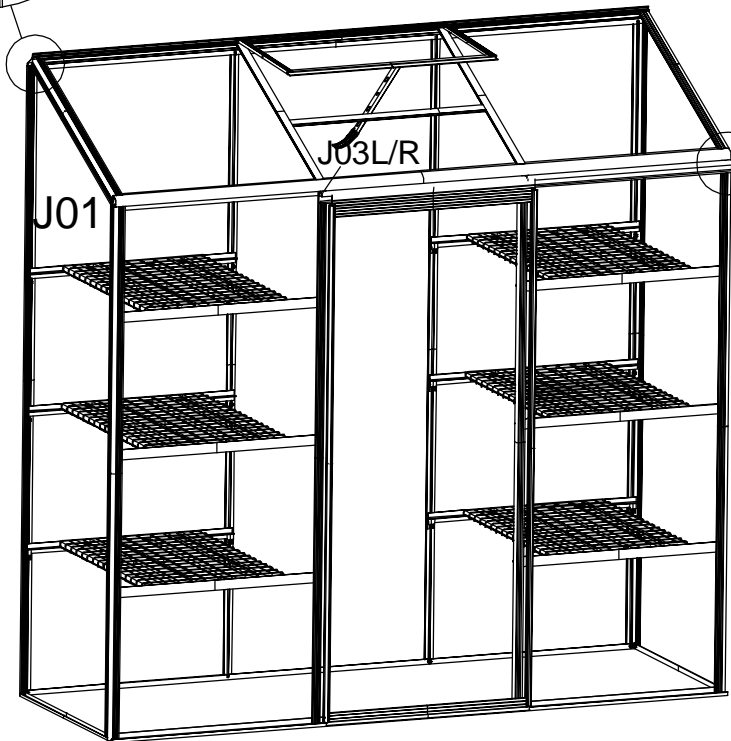
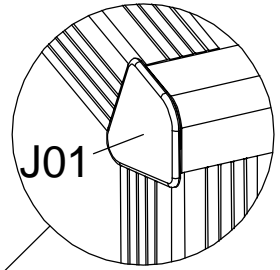

J02R/L



Step 15

PART	NO.	Qty.
	J04	4
	Z01	4

