

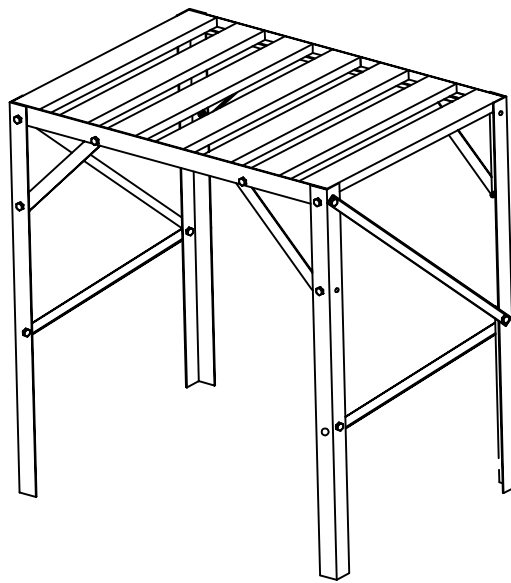







Tier 25" alum. Shelf

Assembly instruction



PRODUCT SIZE(LxWxH): 25" x 20" x 30"

PLEASE READ CAREFULLY BEFORE ASSEMBLY

Part No.	Part	QTY.
L01A		2
L02A		4
L03A		14
L05B		2
L05C		4
L05D		2
S01		32
M01		32

