

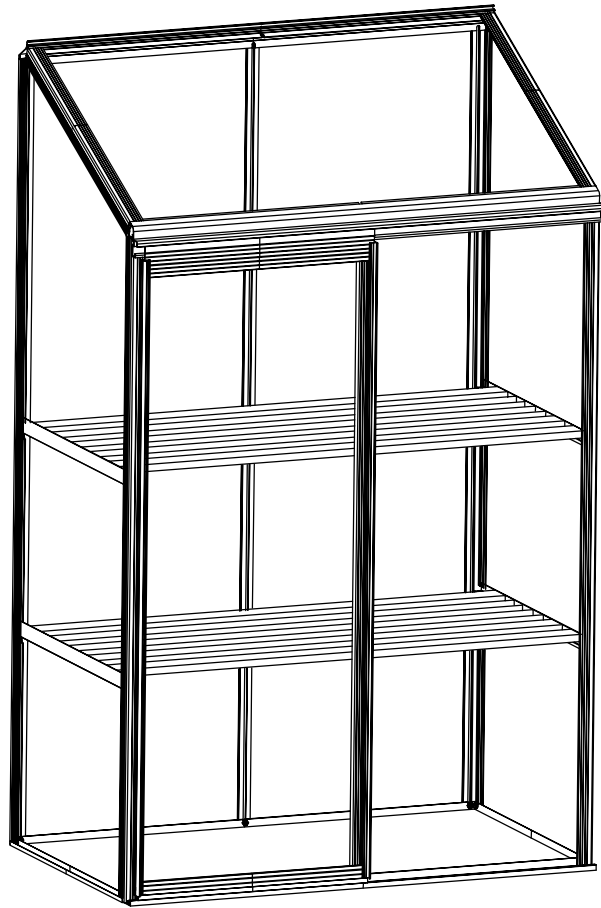



Assembly instruction





PRODUCT SIZE(LxWxH): 1'-11" x 3'-2" x 4'-10"
PLEASE READ CAREFULLY BEFORE ASSEMBLY













P2 Door Frame Assembly

PART	NO.	Qty.
	L15	1
	L16A	1
	L18A	2





P3 Assembly

PART	NO.	Qty.
	L02A	10
	L09	4

P4-P8 Assembly

PART	NO.	Qty.
	L01A	2
	L01B	2
	L01C	1
	L01D	1
	L03A	1
	L04A	1
	L06	1
	L07	1
	L08A	1
	L08B	2
	L10	1
	L14	1



Polycarbonate

PART	NO.	Qty.
	Y1	2
	Y2	2
	Y3	1
	Y4	1
	Y5	1

PARTS



PART	NO.	Qty.
	W01	8
	S01	20
	M01	22
	S02	26
	M02	26
	S03	2
	Z01	8
	J02L/R	1/1
	J01	2
	J03L/R	1/1

Notice: Please make sure the PC panel the side with words faces out.

PART NO.	Qty.
 L15	1
 L16A	1
 L18A	2

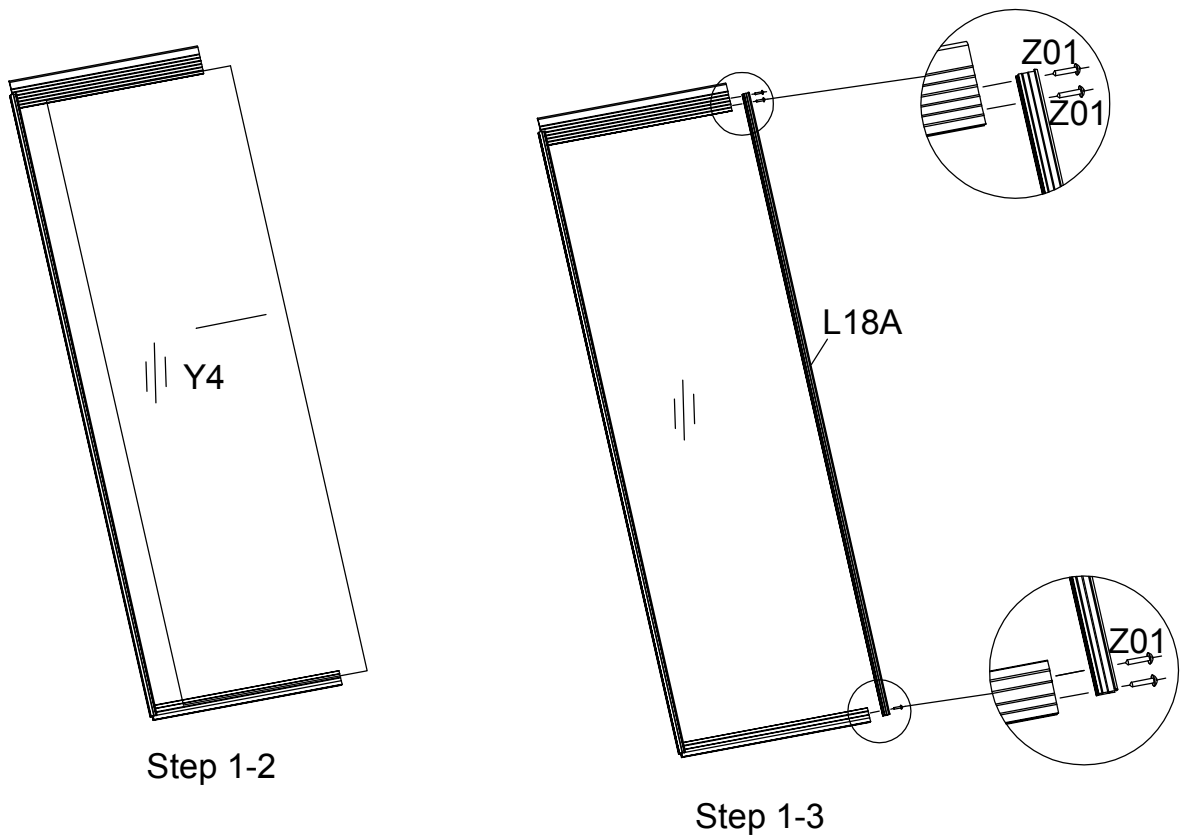
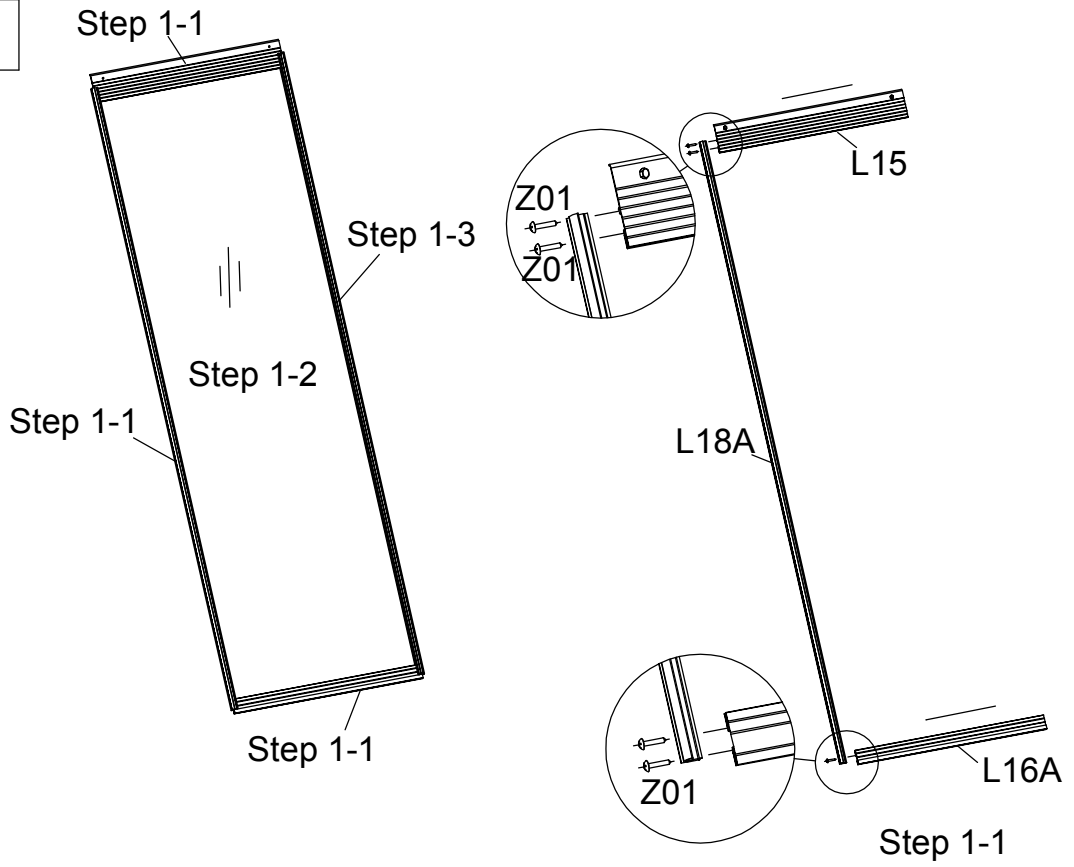
P2 Door Frame Assembly



PART NO.	Qty.
 L02A	10
 L09	4



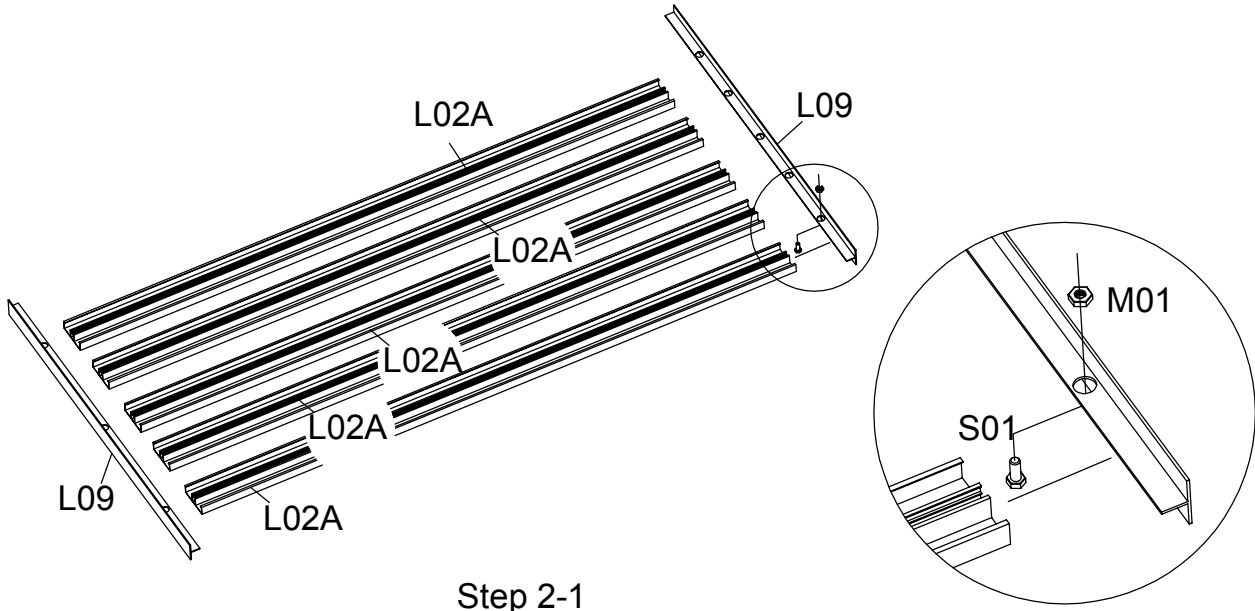



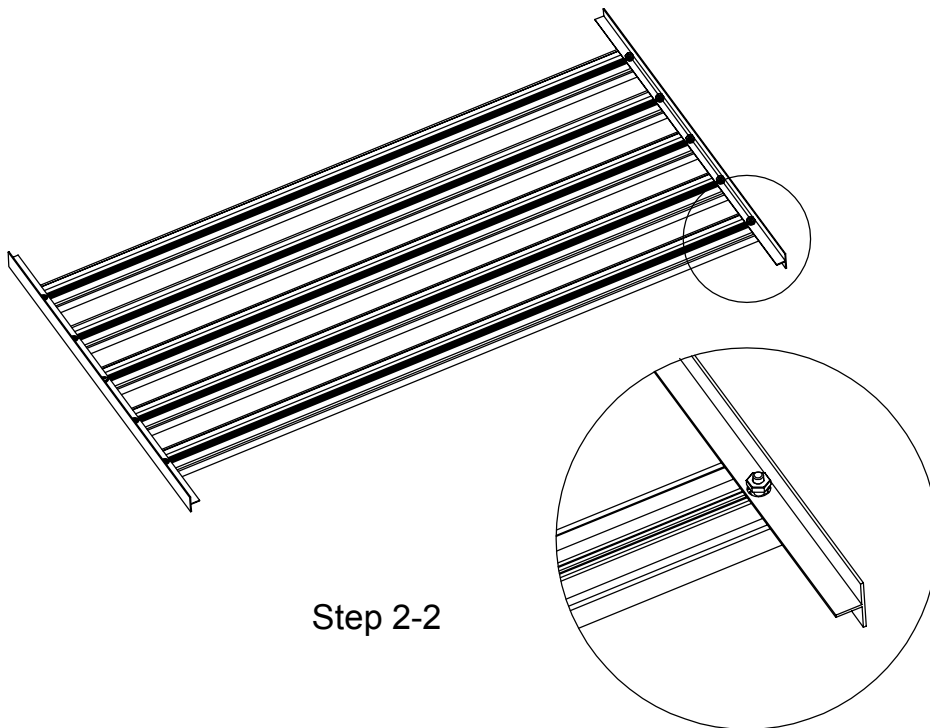





P3 Assembly



Step 2-1



Step 2-2

PART	NO.	Qty.
	L01A	2
	L01B	2
	L01C	1
	L01D	1
	L03A	1
	L04A	1
	L06	1
	L07	1
	L08A	1
	L08B	2
	L10	1
	L14	1

P4-P8 Assembly

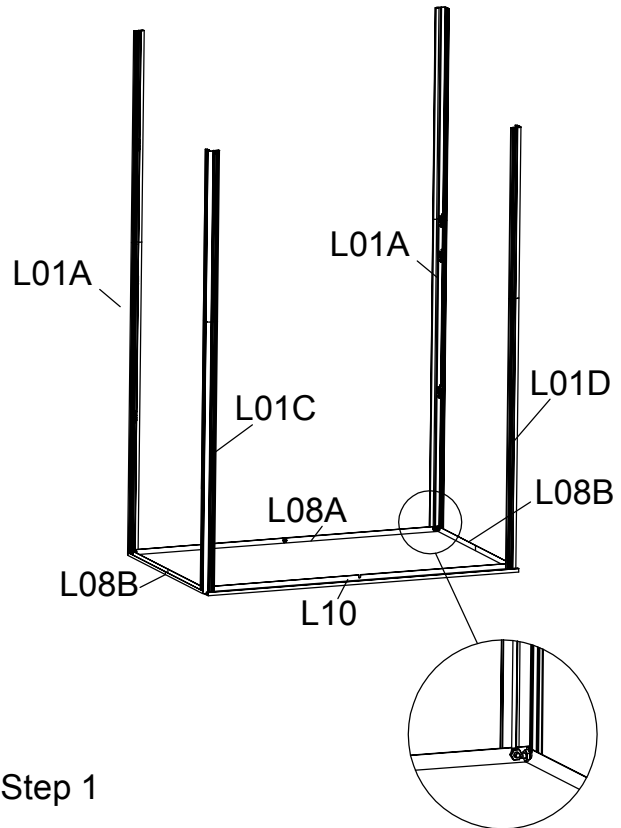

Step 1

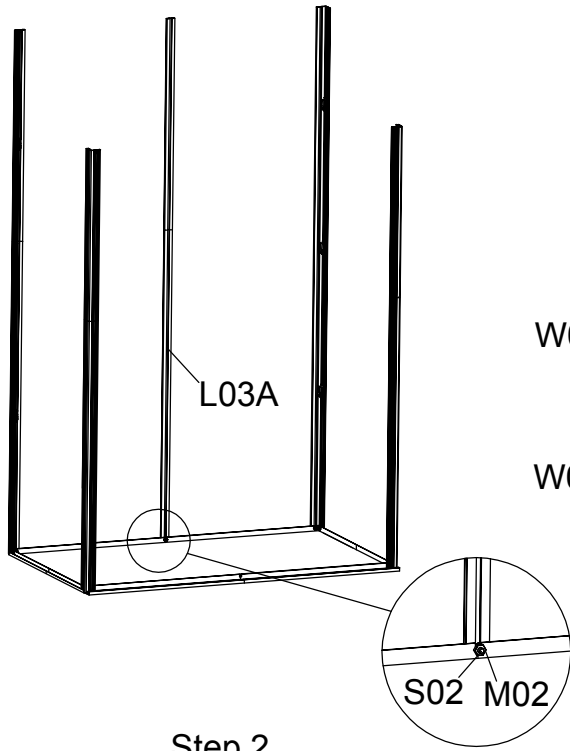

Step 2

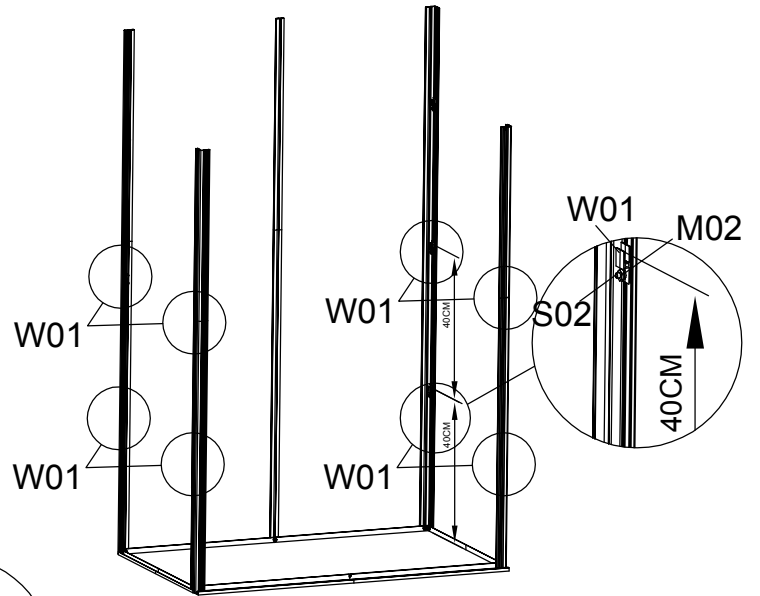

Step 3



Step 4

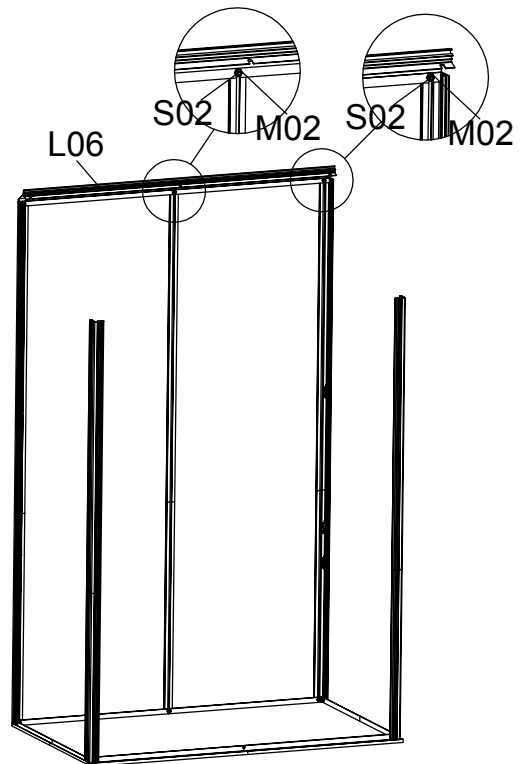

Step 5



Step 6

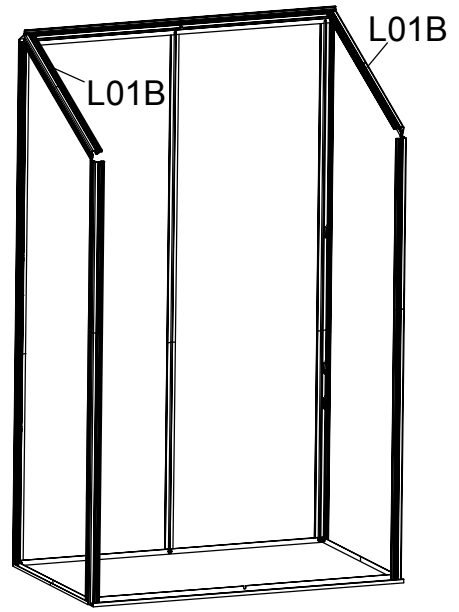

Step 7

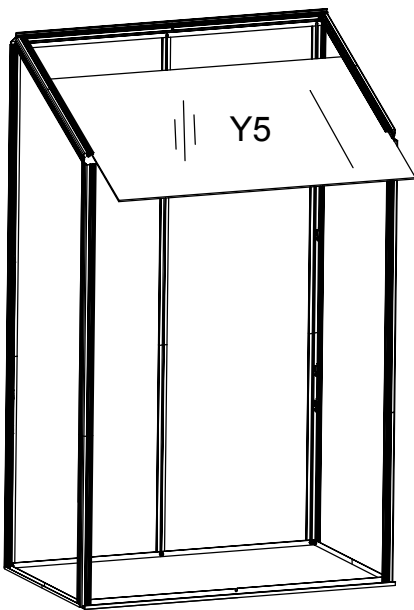

Step 8

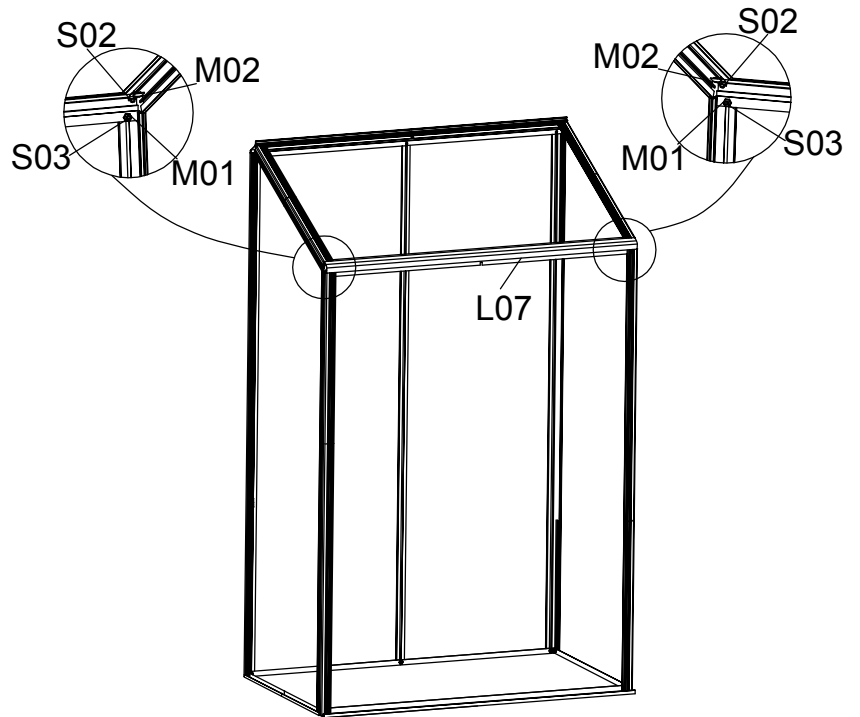

Step 9

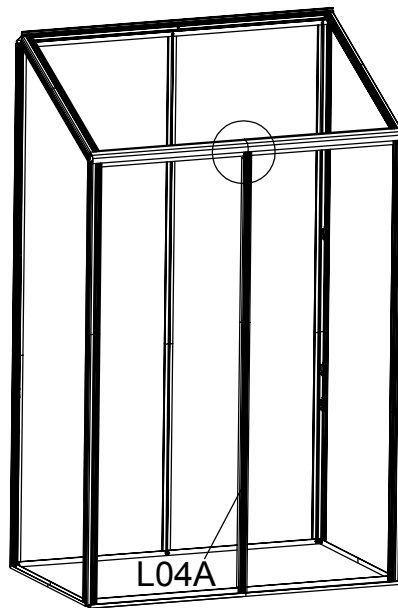

Step 10

Step 11

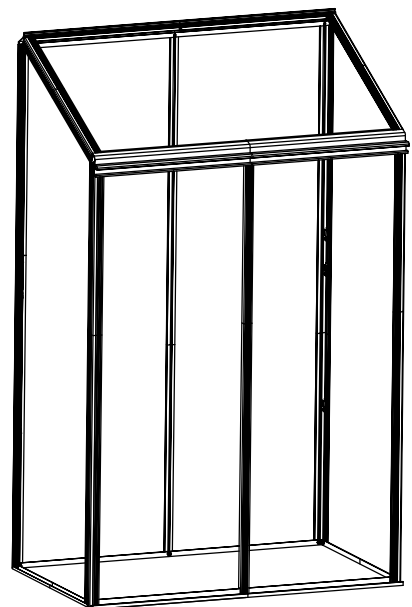
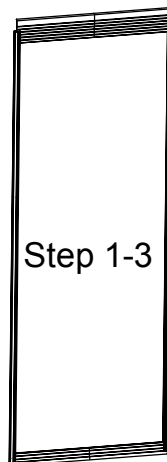
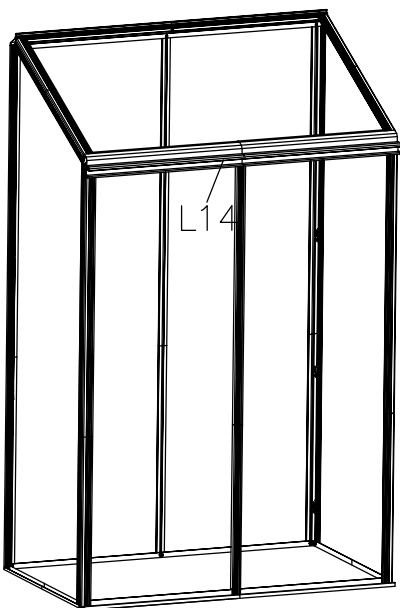
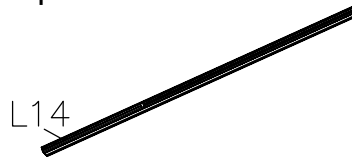
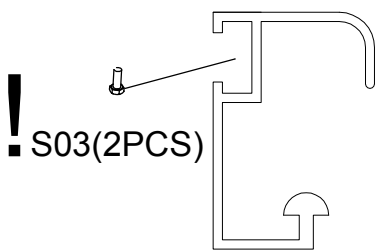

Step 12

Step 13

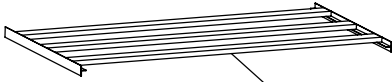

Step 2-2

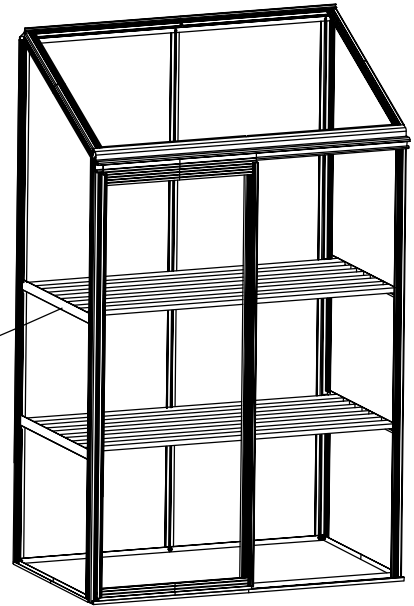

J02R/L

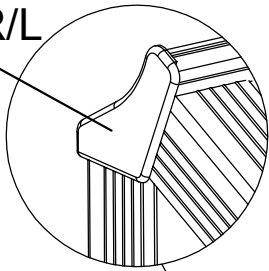

Step 14

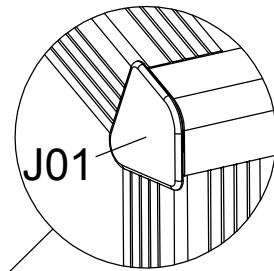

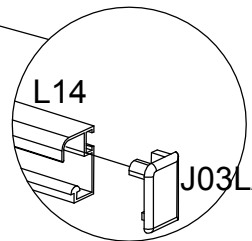
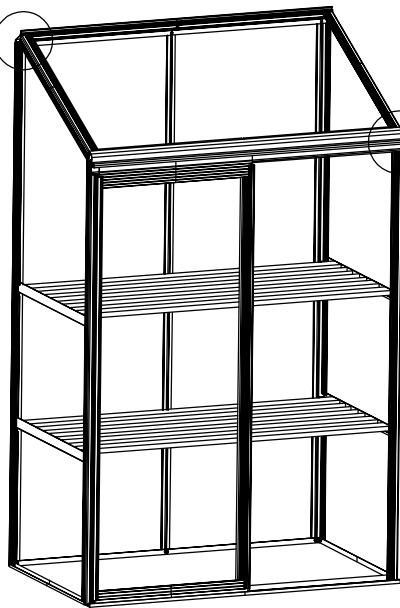

J01



L14

J03L/R

Step 15

PART	NO.	Qty.
	J04	4
	Z01	4

